



SUPER COVER™

COMPOSITE MANHOLE COVERS

A solution to your Sanitary Sewer Overflow problems



www.supercover.com



Designed in Texas

SuperCover™ composite manhole frame & covers were inspired by challenges faced throughout Texas municipalities.



SUPER COVER™
COMPOSITE MANHOLE COVERS

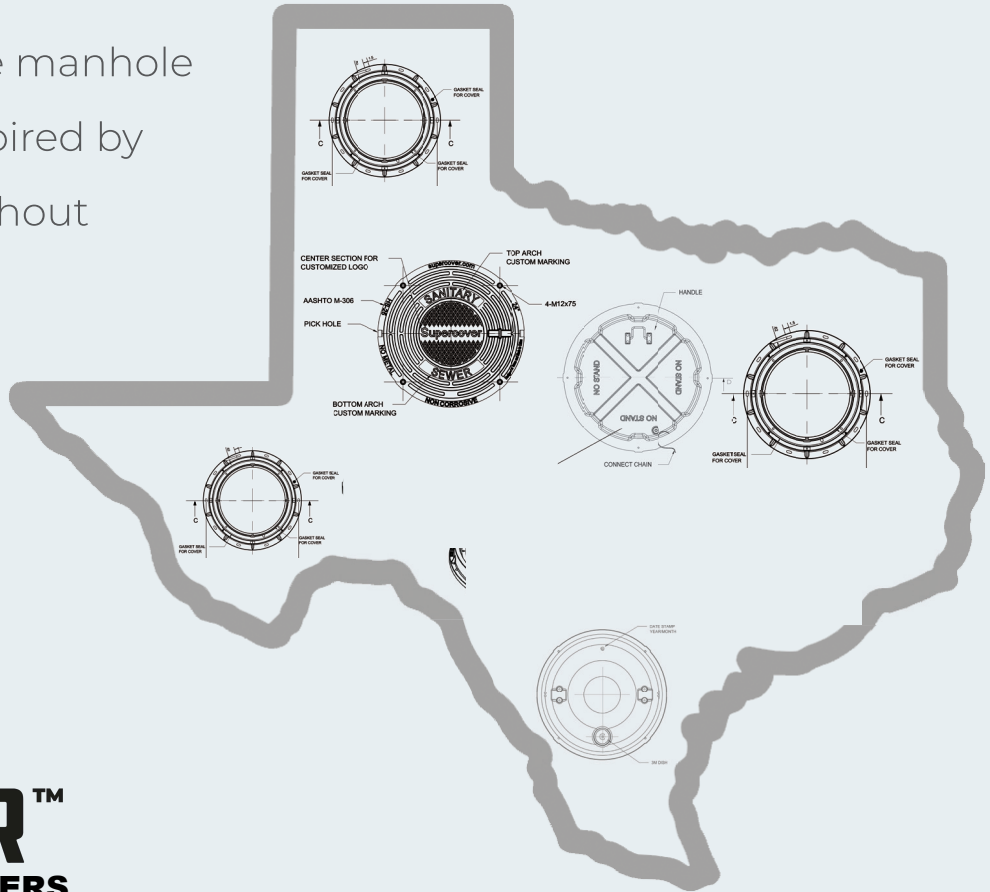

www.supercover.com

We asked...

“ HOW CAN WE HELP
MUNICIPALITIES REDUCE
THEIR SANITARY
SEWER OVERFLOWS? ”



SUPER COVER™

www.supercover.com

NON-HINGED

Bolted Safety Dish

Bolted Safety Dish for Fall Protection

I & I Gasket

Prevents infiltration, exfiltration & odors

316 SS Pick Hole

316 SS 1/2" Bolts

Alignment Locators

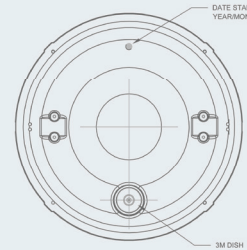
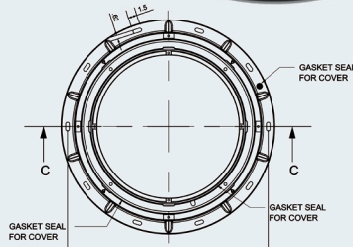
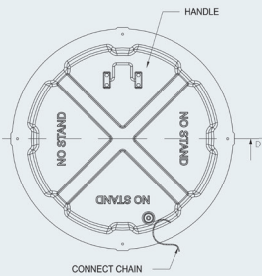
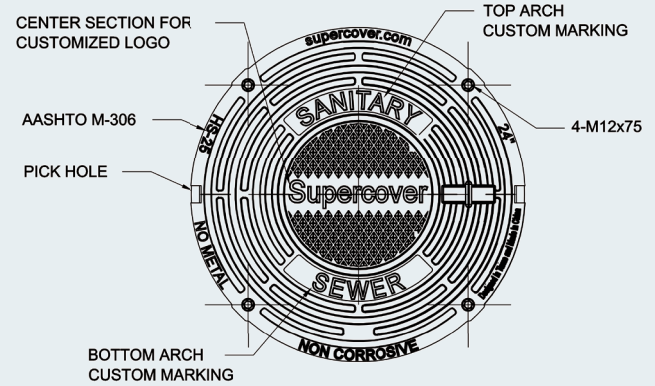

BOLTED SAFETY DISH

	AASHTO M306-10 Proof Load	Clear Opening	Outer Diameter	Rim girth	Locate	INNER DISH	I&I gpm	MASS			
								SAFETY DISH	FRAME	COVER	TOTAL
Super 24 NH SSO Series	HS-25	24" I.D.	36" O.D.	4.0"	3M	Safety Dish	0.0 gpm	9.5	69.3	70.0	148.8
Super 30 NH SSO Series	HS-25	30" I.D.	41" O.D.	4.0"	3M	Safety Dish	0.0 gpm	14.1	81.4	99.5	195.0

Our new **Safety Dish** features:



Bolted Down Safety Dish

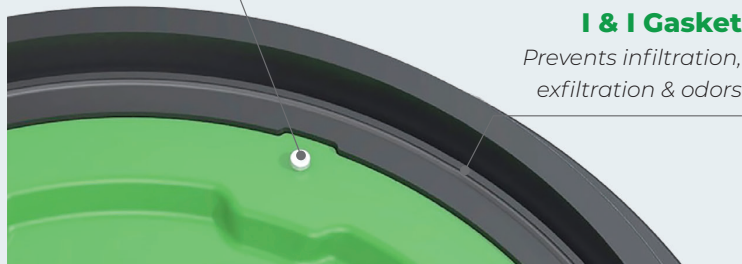

- ✓ ANTI-ROTATING
- ✓ SELF-ALIGNING GUIDES
SuperCover's new self aligning design, easily aligns bolt holes for quick and easy bolting. Design prevents confusion and operator frustration.
- ✓ DOUBLE GASKET
- ✓ BOLTED DOWN SAFETY DISH

Double Gasket protection against **I&I** and **treatment costs!**

Solves wastewater municipalities most common problems



Exceeds 50,000lb proof
load test AASHTO



Water tight



No scrap
metal value



Anti-Corrosive Inert
Composite materials



Locate with: **3M™ iD**
Disk Marker 1414-XR/iD



Odor-eliminating



Anti-Theft



5 year warranty



Manufactured at an
ISO 9000 certified plant



Bolted down to frame,
cover & inner dish



NO unlawful entry:
bolt & locking system



Self-Extinguishing

Tested & Certified

Third Party Tested & Certified

by

The Trenchless Technology Center (TTC) at Louisiana Tech University

SuperCover™

Name

Complies with the requirements of section 6.1

Proof-Load Test H-25 as specified in AASHTO Standard M

306-2, CERTIFIED TO M-306 H-20 & H-25

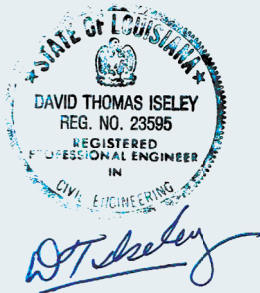

AASHTO



The Trenchless Technology Center (TTC) at Louisiana Tech University

is an independent source of knowledge, research and education for both government entities and the private sector in the field of Trenchless Technology.

www.supercover.com

3M™ iD Disk Marker 1414-XR/iD

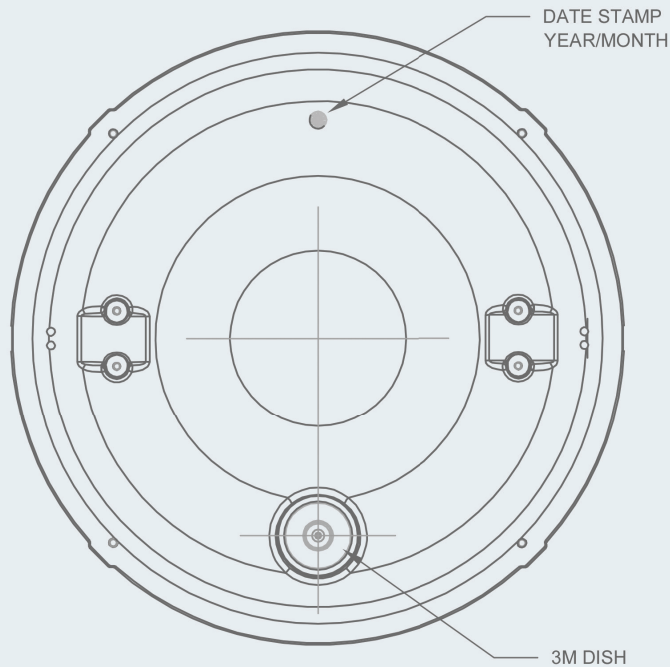

3M™ iD Markers are designed to provide an accurate, convenient, long-lasting method of marking underground assets. In addition, these markers may be programmed to include customer specific information such as facility data, type of application, material type and size, placement date and other important details.



**Premier Distributor
Industrial Products**



3M ID 80611303548, UPC 00051115160943



https://www.3m.com/3M/en_US/company-us/all-3m-products/~3M-Disk-Marker-1414-XR-iD-5-ft-Range-Wastewater-Not-for-Direct-Bury/?N=5002385+3294729747&rt=rud

www.supercover.com

Frequently asked questions



QUESTIONS

ANSWERS

Is the cover manufactured in the USA?

No. Designed in Texas. Made in China

Does it come with a warranty or any guarantee?

Yes, 5 years. No hassle

Is the cover **HS-25** rated?

Yes. Tested and proven

Is the cover kept secure to the frame with a bolt or locking system?

Yes. 4 X 316 SS Bolts

How does the SuperCover™ SSO Series reduce sanitary sewer overflows?

It eliminates water going in and stops sewage water from gushing out

Since the cover is NON-Metallic can it be located?

Yes, by means of a 3M™ iD Marker

Does the unit prevent infiltration & exfiltration?

Yes, by means of gaskets and bolts

SuperCover SSO Series VS. The Competition:

	 SUPER COVER™		
Anti-rotating	✓	x	x
Inflow dish capable	✓	x	x
5 year warranty	✓	x	x
Bolted down Inflow dish	✓	x	x
Double gasket	✓	x	x
Odor prevention	✓	✓	✓
Fall protection Safety dish	✓	x	x
Self-aligning	✓	x	x
HS-25 Load rated	✓	✓	✓

Built for the wastewater industry, *created* by the wastewater industry

If you are a Municipal Operator and would like to share your thoughts on how we could further improve The SuperCover™, contact us at www.supercover.com

www.supercover.com



SUPER COVER™

COMPOSITE MANHOLE COVERS

(956) 264-5188 sales@supercover.com www.supercover.com

Call for pricing

If you are interested in becoming a distributor please contact us

“We **highly recommend** SuperCover as the supplier for HS-25 Load Rated HD Composite Manhole Covers.”

“We have **sold hundreds** of SuperCover composite manhole covers from our warehouse, to multiple cities and contractors with no issues.”

“It is a very **durable and cost-effective** product that keeps our manholes in a safer condition when needed for service.”

“SuperCover composites have **reduced** our staff’s injuries and workman’s compensation associated with prying open fused manhole covers.